

SINGER
141W4,W5

LIST OF PARTS



MACHINES Nos. 141w4 and 141w5

THE SINGER MANUFACTURING COMPANY

INDEX

	PAGES
ACCESSORIES	16
BINDERS	23
BOBBIN WINDER	16
FEED DOGS	18
FINGER GUARD	23
GUIDES	24
HEMMERS	24
KNEE LIFTER	17, 20
MACHINE No. 141w4	17
" " 141w5	18
MISCELLANEOUS PARTS	28
NUMERICAL LIST OF PARTS	29
PRESSER FEET	19
THREAD UNWINDER	18
THROAT PLATES	21
TUCKER	26
WOOD BASE	28

From the Library of Diamond Needle Corp

Instructions for Ordering

In ordering from this list, use **ONLY** the **PART** number in the **FIRST** column.

The number stamped on a Sewing Machine Part is the number of the Single Part only, except when the part includes Set Screws, Clamping Screws, Studs and Rollers Spun on, Small Wires riveted, or Parts soldered together, etc., which it is necessary to furnish in combination.

Every combination of parts sent out has its specific number which, although not stamped on Parts (except in above cases) must be used when ordering the combination.

Each number always indicates the **SAME PART** in whatever list it appears, or for whatever Machine.

The letters after some of the numbers indicate the style of finish only, as follows:

- A. Hardened, Polished and Plated.
- B. Polished and Plated.
- C. Hardened only.
- D. Polished only.
- E. Soft, not polished.
- F. Hardened and Polished.
- H. Blued.

These letters **MUST BE USED** when they appear in the list and **AFTER** the number, as in the list.

In this series:

- 1 to 1500 and 200001 to 201500 are Screw Numbers.
- 1501 to 1800 and 201501 to 201800 are Nut Numbers.
- 1801 to 2000 and 201801 to 202000 are Roller Numbers.
- 2001 to 50000 and 202001 and upward are numbers of Machine Parts.

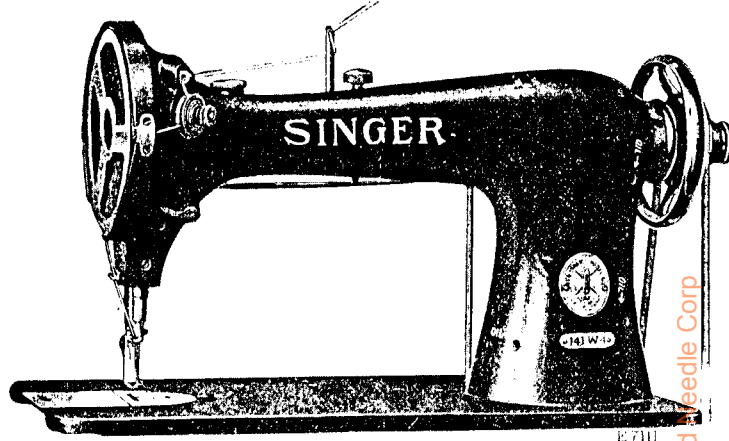
The figures in the second column refer only to the plate in which the illustration of the part is shown and are **NOT TO BE USED** in ordering.

Two or more numbers over a cut indicate that the difference between such parts is not visible in an illustration.

Parts marked with an asterisk (*) are furnished only when repairs are made at the factory.

LIST OF PARTS COMPLETE

FOR



MACHINE No. 141w4

MECHANICAL OPENER. LARGE BOBBIN

For Shirts, Shirt Waists, Wrappers, Corsets, Underwear, etc.

No.	Plate	Name
*241175	---	Arm
204235	13651	" Position Pin (2)
123E	13651	" Screw (back) (2)
201305E	13651	" " (front)
241002	13674	" Shaft with 201400E and 203100
241003	13679	" " Bushing (back) with
		202277
202277	---	Arm Shaft Bushing (back) Oil
		Packing (wick)
1008A	13651	Arm Shaft Bushing (back) Screw
		(3)
241004	13679	Arm Shaft Bushing (front) with
		224392
224392	---	Arm Shaft Bushing (front) Oil
		Packing (wick)
200949B	13675	Arm Shaft Bushing (front) Oil
		Packing Thumb Screw
443C	13651	Arm Shaft Bushing (front) Set
		Screw

From the library of: Diamond Needle Corp

No.	Plate	Name
203100	---	Arm Shaft Oil Packing (wick)
201400E	13651	" " " " Stop Screw ..
12193	13679	" Side Cover
286D	13651	" " " Thumb Screw
241166	13674	Balance Wheel (belt groove 2 $\frac{1}{2}$ in. in. diam.) with 200328c and 200335c
200328c	13651	Balance Wheel Position Screw
200335c	13651	" " Set Screw
*241176	---	Bed
54897	13651	" Oil Cup
241006	---	" Slide
4307	13651	" " Spring
725E	13651	" " " Screw
241007	13679	Bed Slide complete, Nos. 4307, 241006 and two 725E
241008	13675	Bobbin
241009	13675	" Case Base
241010	---	" " Cap with 200594c, 201016c and 241020
241011	13675	Bobbin Case Cap complete, Nos. 200964E, 210736, 241010 and 241013
241012	13675	Bobbin Case Latch
241013	---	" " " 241012 with 206731 and 241014
206731	13675	Bobbin Case Latch Fulcrum Pin ..
241014	13675	" " " Lever
210736	13675	" " " Spring
200964E	13675	" " " Stop Screw
241015	---	Bobbin Case complete, Nos. 241009 and 241011
241158	13675	Bobbin Case Opener
241017	13675	" " " Bushing
443c	13651	" " " " Set Screw
241018	13675	" " " Lever with 200086c
221977	13675	Bobbin Case Opener Lever Link ...
200989D	13675	" " " " " Cap Screw
201392c	13675	Bobbin Case Opener Lever Link Screw Stud
201524E	13675	Bobbin Case Opener Lever Link Screw Stud Nut
200086c	13675	Bobbin Case Opener Lever Pinch Screw
241019	13675	Bobbin Case Stop
896E	13675	" " " Screw
241020	13675	" " Tension Spring
201016c	13675	" " " " Regulat- ing Screw

No.	Plate	Name
200594c	13675	Bobbin Case Tension Spring Screw
241106	13675	Feed Bar
241107	---	" " 241106 with 226D, 241108 and 241109
241022	13651	Feed Bar Connecting Spring
241023	13651	" " " " Clamp Plate (2)
201389c	13651	Feed Bar Connecting Spring Clamp Plate Screw (2)
*241024	---	Feed Bar Lifting Spring
241025	13651	" " " " Pin
*241026	---	" " " " Reinforce- ment
*241027	---	Feed Bar Lifting Spring Reinforce- ment Pin
241121	---	Feed Bar Lifting Spring complete, Nos. 241024, two each 241026 and 241027
241028	13651	Feed Bar Spring
241110	13651	" " " Pin (2)
241029	13661	" Dog
241125	13677	" " Adjusting Block (high) ..
241108	13677	" " " " (low) ...
226D	13651	" " " " Screw
241109	13677	" " " " " " Washer
896E	13675	Feed Dog Screw
241055	13674	" Driving Connection with 202277 and two 200046E
202277	---	Feed Driving Connecting Oil Pack- ing (wick)
200046E	13651	Feed Driving Connection Screw ..
202300	13679	" " Eccentric Regulating Bracket
241056	---	Feed Driving Eccentric Regulating Bracket 202300 with 241102, two each 200256D and 201525E
200256D	---	Feed Driving Eccentric Regulating Bracket Hinge Screw
201525E	13651	Feed Driving Eccentric Regulating Bracket Hinge Screw Nut
202301	13651	Feed Driving Eccentric Regulating Bracket Plunger
202595	13651	Feed Driving Eccentric Regulating Bracket Plunger Spring
200607c	13651	Feed Driving Eccentric Regulating Bracket Plunger Spring Stop Screw
200256D	13651	Feed Driving Eccentric Regulating Bracket Stop Screw

No.	Plate	Name
201525E	13651	Feed Driving Eccentric Regulating Bracket Stop Screw Nut
200429c	13651	Feed Driving Eccentric Regulating Screw
200383c	13651	Feed Driving Eccentric Regulating Screw Check Screw
241162	13674	Feed Driving Rock Sleeve
241160	13679	" " " Bearing with 202330 (2)
202330	—	Feed Driving Rock Sleeve Bearing Oil Packing (wick)
1149c	13677	Feed Driving Rock Seeve Bearing Set Screw (2)
241058	13651	Feed Driving Rock Sleeve Connecting Spring
241059	13651	Feed Driving Rock Sleeve Connecting Spring Clamp Plate (2)
201388c	13677	Feed Driving Rock Sleeve Connecting Spring Clamp Plate Screw (2)
241062	13674	Feed Lifting Connecting with 202277 and two 200046E
202277	—	Feed Lifting Connection Oil Packing (wick)
200046E	13651	Feed Lifting Connection Screw
241063	13679	" " Eccentric with 455c and 1299C
1299c	13651	Feed Lifting Eccentric Position Screw
455c	13677	Feed Lifting Eccentric Set Screw ..
241163	13674	" " Rock Sleeve with 201392c and 201524E
241160	13679	Feed Lifting Rock Sleeve Bearing with 202330 (2)
202330	—	Feed Lifting Rock Sleeve Bearing Oil Packing (wick)
1149c	13677	Feed Lifting Rock Sleeve Bearing Set Screw (2)
241058	13651	Feed Lifting Rock Sleeve Connecting Spring
241059	13651	Feed Lifting Rock Sleeve Connecting Spring Clamp Plate (2)
201388c	13677	Feed Lifting Rock Sleeve Connecting Spring Clamp Plate Screw (2)
241122	13679	Feed Regulating Spindle with 202311, 202443, 202619 and 210554
*202311	—	Feed Regulating Spindle Head
202443	13677	" " " " Pin
202619	13677	" " " " Position Pin

No.	Plate	Name
210554	13677	Feed Regulating Spindle Spring (flat)
*241066	—	Hook (sewing)
241184	13674	" 241066 with 465c, 241069, 241072, 241186, 241187, 350228c and six 1053D
241185	—	Hook and Bobbin Case complete, Nos. 241015 and 241184
*241069	—	Hook Gib
1053D	13656	" " Screw
241186	—	" Oil Packing (wick)
350228c	—	" Position Screw
465c	13677	" Set Screw
*241187	—	" Shaft
241111	13677	" " Bevel Gear with two 1253c
201318E	13677	Hook Shaft Bevel Gear Guard Oil Stop Screw
50234D	13677	Hook Shaft Bevel Gear Guard Oil Stop Screw
241171	—	Hook Shaft Bevel Gear Guard Oil Stop Screw Washer (leather) ..
121E	13677	Hook Shaft Bevel Gear Guard Screw
*241177	—	Hook Shaft Bevel Gear Guard Section (back)
*241178	—	Hook Shaft Bevel Gear Guard Section (front)
241179	13679	Hook Shaft Bevel Gear Guard complete, Nos. 121E, 50234D, 201318E, 241171, 241177 and 241178
1253c	13677	Hook Shaft Bevel Gear Guard Set Screw
241180	13677	Hook Shaft Bushing (back) with 202423
202423	—	Hook Shaft Bushing (back) Oil Packing (wick)
241188	13677	Hook Shaft Bushing (front) with 241189
241189	—	Hook Shaft Bushing (front) Oil Packing (wick)
443c	13651	Hook Shaft Bushing Set Screw (2)
241071	13656	" " Oil Leader (brass)
241072	13677	" Thread Draw
1053D	13656	" " " Screw (3)
241120	—	Knee Lifter Bell Crank
241073	—	" " " " Bracket
178c	13656	" " " " " Screw (2)

No.	Plate	Name
5601	13656	Knee Lifter Bell Crank Hinge Pin
5735	13656	" " " " Spring
241074	13679	Knee Lifter Bell Crank complete, Nos. 5601, 5735, 241073 and 241120
241075	13674	Knee Lifter Lifting Lever with 448c
222090	13679	" " " " Connecting Rod
12416	13656	Knee Lifter Lifting Lever Connect- ing Rod Joint
76D	13656	Knee Lifter Lifting Lever Connect- ing Rod Joint Hinge Screw
1521E	13656	Knee Lifter Lifting Lever Connect- ing Rod Lock Nut
802D	13656	Knee Lifter Lifting Lever Hinge Screw
241076	13656	Knee Lifter Lifting Lever Pin ...
448c	13677	" " " " " Set Screw
241077	13656	Needle Bar with 200141E and 200394c
241078	13656	Needle Bar Bushing
241124	—	" " " 241078 with 241077
200396c	13656	" " " Set Screw
241079	13656	Needle Bar Connecting Link with two 187D
40217	13677	Needle Bar Connecting Link Oil Tube
29599	—	Needle Bar Connecting Link Oil Tube Packing (felt)
210933	—	Needle Bar Connecting Link Oiling Wick
187D	13656	Needle Bar Connecting Link Screw
210545	13656	" " " " Swivel with 200387c
241080	13679	Needle Bar Crank with 435c, 855c and 210933
241081	13656	Needle Bar Crank Oil Leader (brass)
855c	13656	Needle Bar Crank Position Screw
435c	13656	" " " Set Screw
200394c	13656	" " Screw
200387c	13656	" " Set Screw
200141E	13656	" Set Screw
241082	13657	Presser Bar with 190D
241083	13657	" " Bushing
200396c	13656	" " " Set Screw
202339	13657	" " Lifter
200666c	13657	" " " Hinge Screw ...

No.	Plate	Name
241084	13657	Presser Bar Lifting Bracket
241085	13657	" " Position Guide
241086	13657	" " " " Lever with 176D
176D	13657	Presser Bar Position Guide Lever Pinch Screw
200396c	13656	Presser Bar Position Guide Set Screw
241087	13674	Presser Bar Spring (flat)
201394E	13657	" " " Regulating Thumb Screw
18D	13657	Presser Bar Spring Support Screw
40315	5863	" Foot
190D	13657	" " Screw
241151	13674	Take-up Plate (inner)
210983	13658	" " " Position Pin
401D	13658	" " " Screw (2) ...
241152	13674	" " (outer)
241153	13658	" " Division Washer ...
241154	13658	" " Rivet
241155	—	Take-up (rotary) complete, Nos. 241151, 241152, two each 241153 and 241154
2102	10881	Tension Disc
1560B	13658	" Thumb Nut
32572	13658	" Release Disc
241156	13658	" " Lever
241096	13658	" " " Crank with 176D
176D	13657	" " " " Pinch Screw
241157	13658	" " " Washer
202075	13658	" " Plunger
241097	13658	" " Rod
241098	13658	" " " Spring
13710	13658	" Spring
201393c	13658	" Stud
241099	13658	Tension complete, Nos. 1560B, 13710, 32572, 201393c, 202075 and two 2102
210954	13658	Thread Guide
241167	13677	" " (lower) with 200141E and 232382
241168	—	Thread Guide 241167 with 241169 and 241170
200583H	13677	Thread Guide (lower) Screw (2) ...
202412	13658	" " (on top of Arm)
29642	13658	" " (upper)
460c	13677	" " " Set Screw
200583H	13677	" " Screw
241169	13677	" Nipper
241170	13677	" " Hinge Stud (eccentric)

No.	Plate	Name
200141F	13656	Thread Nipper Hinge Stud Set Screw
232382	13677	Thread Nipper Stop Pin
52033	13661	Throat Plate (small needle hole) ..
691F	13677	" " Screw (2)
241101	13679	Vertical Shaft
241111	13677	" " Bevel Gear (lower) with two 1253c
241114	13677	Vertical Shaft Bevel Gear (upper) with two 1253c
1253c	13677	Vertical Shaft Bevel Gear Set Screw
241182	13677	Vertical Shaft Bushing (lower), $\frac{5}{8}$ in. diam., with 202423
202423	—	Vertical Shaft Bushing (lower) Oil Packing (wick)
430c	13677	Vertical Shaft Bushing (lower) Set Screw
241183	13677	Vertical Shaft Bushing (upper), $\frac{5}{8}$ in. diam., with 202423
202423	—	Vertical Shaft Bushing (upper) Oil Packing (wick)
443c	13651	Vertical Shaft Bushing (upper) Set Screw
241102	13679	Vertical Shaft Driving Bevel Gear with 444F and 1036c
444F	13677	Vertical Shaft Driving Bevel Gear Position Screw
1036c	13677	Vertical Shaft Driving Bevel Gear Set Screw
241103	13677	Vertical Shaft Oil Leader (lower) (brass)
241104	13677	Vertical Shaft Oil Leader (upper) (brass)

MACHINE No. 141w5

MECHANICAL OPENER. LARGE BOBBIN

ROLLER PRESSER

For Leather

Same as Machine No. 141w4 with the following exceptions:

No.	Plate	Name
241202	13676	Feed Dog, in place of 241029
241201	13677	Needle Bar with 200141F and 200394c, in place of 241077
241203	—	Needle Bar Bushing 241078 with 241201, in place of 241124
1903	13678	Roller, $1\frac{1}{4}$ in. diam. (coarse), with 652D and 1528D
52453	13678	Roller Arm
440F	13678	" " Adjusting Screw
1547J	13678	" " " " Nut ..
4282	13678	" " Bracket
316F	13678	" " " " Screw Center ..
1547J	13678	" " " " " Nut ..
2205	13678	" " Lock Spring
176D	13657	" " " " Screw
1549J	13678	" " " " " Nut ..
652D	13678	" " Screw
1528D	13678	" " Nut
52414	13678	Roller Presser complete, $1\frac{1}{4}$ in. diam. (coarse roller), Nos. 176D, 440F, 1549J, 1903, 2205, 4282, 52453, two 316F and three 1547J ..
241095	13678	Tension Release Lever, in place of 241156
24444	13676	Throat Plate (large oblong hole), in place of 52033

From the library of: Diamond Needle Corp

ACCESSORIES

FOR MACHINE No. 141w4

No.	Plate	Name
241008	13675	Bobbin (3)
*120092	—	Screw Driver Blade
*120093	—	“ “ Ferrule
*120094	—	“ “ Handle with 120093 ..
26485	13680	“ “ Nos. 120092 and 120094
88 x 1	—	Needles, two each, sizes 14, 16 and 18
24079	—	Drip Pan with four 1 in. wire nails
41400	13680	“ “ Pin (wood)
12361	13680	Machine Hinge Connection
20022	—	“ Rest (felt) (4)
120342	13680	Oiler (copper plated) with 120343 ..
120343	13680	“ Spout, 3½ in. long
*120088	—	Screw Driver Blade
*120089	—	“ “ Ferrule
*120090	—	“ “ Handle with 120089 ..
26026	13680	“ “ Nos. 120088 and 120090
225554	13680	Wrench (steel)

BOBBIN WINDER

Swing Automatic, Right Hand

225453	10884	Frame with 202277 and 225438
225454	10884	“ Hinge Pin
202277	—	“ Oil Packing (wick)
225438	10884	“ “ Well Cap
225455	10884	“ Spring
225456	10884	“ “ Plunger
202473	10885	Pulley with 200380c
200380c	13678	“ Set Screw
225381	10884	Spindle
225444	10884	Stop Latch
200056e	10884	“ “ Screw
225458	10884	“ “ Thumb Lever
225459	10884	“ “ “ “ Hinge Stud
225460	10884	“ “ “ “ Joint Stud
202478	10884	“ “ Trip Lever
200299H	10884	“ “ “ “ Hinge Screw
225461	10881	Tension Bracket with 201499B ...
200082D	10881	“ “ Screw
228026	10884	“ “ “ Washer

No.	Plate	Name
2102	10881	Tension Disc
202407	10881	“ Spring
201499B	10881	“ Stud
201572B	10881	“ “ Thumb Nut
225462	10881	Bobbin Winder Tension Bracket complete, Nos. 201572B, 202407, 225461 and two 2102
225433	10885	Bobbin Winder and Tension Bracket Base
225382	10885	Universal Bobbin Winder complete, Nos. 200056E, 200082D, 200299H, 202473, 202478, 225381, 225433, 225444, 225453 to 225456, 225458 to 225460, 225462, 228026 and two wood screws ¾ in., No. 12, R.H.B.

KNEE LIFTER

2763	5877	Rock Shaft
12242	5877	“ “ Hanger with two wood screws 1 in., No. 10
2765	5877	Rock Shaft Knee Arm
2766	5877	“ “ “ “ Hub with 356c
356c	13665	“ “ “ “ “ Set Screw
2768	—	Rock Shaft Knee Arm complete, Nos. 2765 to 2767
2767	5877	Rock Shaft Knee Plate with 356c ..
356c	13665	“ “ “ “ “ Set Screw ..
6337	5877	“ “ Lifting Bracket with two 356c
2778	5877	Rock Shaft Lifting Bracket Hook
356c	13665	“ “ “ “ “ “
356c	13665	Set Screw
356c	13665	Rock Shaft Lifting Bracket Set Screw
2770	5877	Rock Shaft Stop Dog with 356c ...
356c	13665	“ “ “ “ “ Set Screw ..
2777	5877	Rock Shaft complete, Nos. 2763, 2768, 2770, 2778, 6337 and two 12242

(Other Knee Lifter parts are listed with
parts of machine head.)

THREAD UNWINDER

No.	Plate	Name
225395	14263	Spool Rest (for two spools) with 201018c
225388	14263	Spool Rest Rod
200383c	13651	" " " Set Screw
201018c	13678	" " " Set Screw
202490	14263	" Stand with 200383c
225391	14263	Thread Guide
201696J	13678	" " Lock Nut
225392	14263	" " Rod with 208E and 225393
208E	13678	Thread Guide Rod Screw
225393	13678	" " Washer
225396	14263	Thread Unwinder (for two spools) complete, Nos. 201696J, 202490, 225388, 225392, 225395, two 225391 and three wood screws $\frac{3}{8}$ in. No. 12

FOR MACHINE No. 141w5

Same as for No. 141w4 with the following exception:

16 x 230	—	Needles, six, size 16, in place of 88x1, two each, sizes 14, 16 and 18
----------	---	--

FEED DOGS

No.	Plate	Name
241029	13661	Feed Dog, for 52032 and 52033
241037	13676	" " " 241143
241031	13662	" " " shirt work, beveled for Hemmer, for 20139 and 20140
241032	13661	Feed Dog, for 20124 and 20125
241033	13662	" " " 26605 and 26606
241034	13676	" " " 36526
241038	13676	" " " 241143

PRESSER FEET

No.	Plate	Name
12143	5864	Presser Foot
12144	5864	" "
12260	5864	" "
12261	5864	" "
20150	5863	" "
20342	5863	" "
12462	5866	" " for $\frac{3}{16}$ to $\frac{1}{4}$ in. gauge ..
20118	5862	" " " general work
12335	5865	" " (narrow)
12463	5866	" " with strip guide
20343	5865	" " " guide on bottom to the right of needle hole
12435	5865	Presser Foot with 228D
26279	5089	" " Extension, $\frac{1}{16}$ inch ..
26280	5089	" " " $\frac{1}{8}$ inch
26281	5089	" " " $\frac{1}{4}$ inch
26282	5089	" " " $\frac{3}{8}$ inch
26283	5089	" " " $\frac{1}{2}$ inch
228D	13665	" " " Screw
26276	13665	" " Hinge Pin
7298	13665	" " " "
62527	13665	" " " "
36464	5892	" " Spring Guide
665D	5892	" " " " Screw ..

No.	Plate	Name
36465	5892	Presser Foot (right hand, spring guide) with 665D and 36464, for $\frac{3}{16}$ to $\frac{5}{16}$ in. gauge
Note. When ordering No. 36464 or 36465 state required distance from edge of goods to seam.		
36574	5945	Presser Foot
36575	5945	" " 36574 with 36576 and two 50202D
36576	5945	Presser Foot Finger Guard
50202D	5945	" " " " Screw ..
36714	---	" " with 233D
36715	5892	" " Guide (right) with 36716
233D	5892	Presser Foot Guide Set Screw
36716	5892	" " " Stud
36717	5892	Presser Foot complete with Adjustable Guide (right), Nos. 36714 and 36715
36773	5892	Presser Foot, for braiding
20133	---	" " Plate, for 20134
20155	---	" " " " 20157
20268	---	" " " " 20270
20344	---	" " " " 20346
20360	---	" " " " 20361
20472	---	" " " " 20474
24544	---	" " " " 24983
40316	---	" " " " 40318
52034	---	" " " " 52036
19223	---	" " Shank
20156	---	" " "
20269	---	" " "
20345	---	" " "
19335	---	" " "
20473	---	" " "
24982	---	" " "
40317	---	" " "
52035	---	" " "
26231	---	" " Spring
25967	5089	" " Strip Gauge
228D	13665	" " " Screw ..
20134	5866	Presser Foot (hinge) complete, for $\frac{3}{8}$ to $\frac{1}{2}$ in. gauge. Nos. 19223, 20133 and 26276
20157	5865	Presser Foot (hinged) complete, Nos. 228D, 20155, 20156 and 62527
20270	5862	Presser Foot (hinged) complete, Nos. 7298, 20268 and 20269

No.	Plate	Name
20346	5862	Presser Foot (spring hinged) complete, Nos. 20344, 20345, 26231 and 62527
20361	5866	Presser Foot (hinged), plain bottom, complete, Nos. 19335, 20360 and 26276
20474	5862	Presser Foot (spring hinged) complete, Nos. 20472, 20473, 26231 and 62527
24983	5867	Presser Foot (spring hinger) complete, Nos. 24544, 24982, 26231 and 62527
40318	13664	Presser Foot (hinged) complete, for lace running, Nos. 40316, 40317 and 62527
52036	5863	Presser Foot (hinged) complete, Nos. 26276, 52034 and 52035

THROAT PLATES

36526	---	Throat Plate, for 241034
241143	13676	" " 53 needle hole, for needle sizes 12 and 13, for 241037
20124	13661	Throat Plate, large needle hole, for 241032
20139	13662	Throat Plate, large needle hole, for 241031
26605	13662	Throat Plate, large needle hole, for 241033
52032	13661	Throat Plate, large needle hole, for 241029
20140	13662	Throat Plate, small needle hole, for 241031
20125	13661	Throat Plate, small needle hole, for 241032
26606	13662	Throat Plate, small needle hole, for 241033
52033	13661	Throat Plate, small needle hole, for 241029

BINDERS

No.	Plate	Name
230251	13670	Binder Clamp Washer
231079	—	" Guide, for tapes or folded strips from $\frac{3}{8}$ to $\frac{1}{2}$ in., in steps of $\frac{1}{16}$ inch
200907B	13670	Binder Guide Screw
231078	13670	" Head, for tapes or folded strips from $\frac{3}{8}$ to $\frac{1}{2}$ in., in steps of $\frac{1}{16}$ inch
231080	—	Binder Tension Bracket with nine 226648
190D	13670	Binder Tension Bracket Screw (2)
225648	13670	" " Pin
231081	13670	Binder Tension Bracket complete, Nos. 231079, 231080 and two 200907B
200507B	13678	Binder Thumb Screw
231084	13670	Feed Dog
231086	—	Presser Foot, for use with $\frac{3}{8}$ in. binder
231087	13670	Presser Foot, for use with $\frac{7}{16}$ in. binder
231082	—	Presser Foot, for use with $\frac{1}{2}$ in. binder
231088	—	Presser Foot, for use with $\frac{9}{16}$ in. binder
231089	—	Presser Foot, for use with $\frac{5}{8}$ in. binder
231090	—	Presser Foot, for use with $\frac{11}{16}$ in. binder
231091	—	Presser Foot, for use with $\frac{3}{4}$ in. binder
231083	13670	Throat Plate, 53 needle hole, for needle sizes 12 and 13, for use with $\frac{3}{8}$ to $\frac{1}{2}$ in. binders
231085	—	Throat Plate, 53 needle hole, for needle sizes 12 and 13, for use with $\frac{1}{2}$ to $\frac{3}{4}$ in. binders

BINDER

35208	1971	Binder on Shank, to turn in both edges for bias or straight binding, for skirts, wrappers, shirt waists, etc.
-------	------	--

No.	Plate	Name
241033	13662	Feed Dog, for 26605 and 26606
52055	—	Presser Foot
26605	13662	Throat Plate, large needle hole, for 241033
26606	13662	Throat Plate, small needle hole, for 241033

FINGER GUARD

36818	5945	Finger Guard
36819	5945	" " Friction Washer
50316J	5945	" " Hinge Screw
36820	5945	" " Holder with 196J ...
196J	5945	" " Clamping Screw
36821	5945	Finger Guard complete, Nos. 36818 to 36820 and 50316J

GUIDES

25866	6449	Guide
25878	6449	"
732D	13678	" Thumb Screw

HEMMERS

No.	Plate	Name
36118	---	Hemmer (foot), $\frac{3}{8}$ in. hem
36119	5881	" " $\frac{1}{4}$ in. hem
36120	---	" " $\frac{3}{8}$ in. hem
36121	---	" " $\frac{1}{2}$ in. hem
36122	---	" " $\frac{5}{8}$ in. hem
36749	---	" " $\frac{1}{4}$ in. hem
225423	13664	" Foot, $\frac{3}{8}$ in. hem
225421	13664	" " $\frac{1}{2}$ in. hem
225424	13664	" " $\frac{1}{4}$ in. hem
225425	13664	" " $\frac{3}{8}$ in. hem
225422	---	" " $\frac{1}{2}$ in. hem
225426	13664	" " $\frac{3}{8}$ in. hem
225427	---	" " $\frac{1}{2}$ in. hem
225428	13664	" " $\frac{1}{4}$ in. hem
6267	---	" Folder
25888	---	" Tongue
Note. When ordering Nos. 6267 or 25888 give width of hem and No. of Hemmer for which it is required.		
241032	13661	Feed Dog, for 20124 and 20125
20124	13661	Throat Plate, large needle hole, for 241032
20125	13661	Throat Plate, small needle hole, for 241032
35710	---	Hemmer (foot), $\frac{3}{8}$ in. hem, with guide on bottom to the right of needle hole
35682	13664	Hemmer (foot), $\frac{1}{4}$ in. hem, with guide on bottom to the right of needle hole
36524	---	Hemmer (foot), $\frac{3}{8}$ in. hem, with guide on bottom to the right of needle hole
35997	---	Hemmer (foot), $\frac{1}{2}$ in. hem, with guide on bottom to the right of needle hole
36309	---	Hemmer (foot), $\frac{3}{8}$ in. hem, with guide on bottom to the right of needle hole
36072	---	Hemmer (foot), $\frac{1}{4}$ in. hem, with guide on bottom to the right of needle hole
241034	13676	Feed Dog, for 36526
36526	---	Throat Plate, for 241034
36162	---	Hemmer (foot), $\frac{3}{8}$ in. hem, for China silk, etc.

No.	Plate	Name
36432	5881	Hemmer (foot), $\frac{1}{4}$ in. hem, for China silk, etc.
36433	---	Hemmer (foot), $\frac{3}{8}$ in. hem, for China silk, etc.
36434	---	Hemmer (foot), $\frac{1}{2}$ in. hem, for China silk, etc.
241029	13661	Feed Dog, for 52032 and 52033 ...
52032	13661	Throat Plate, large needle hole, for 241029
52033	13661	Throat Plate, small needle hole, for 241029
36413	---	Hemmer (foot), plain bottom, $\frac{1}{8}$ in. hem
36414	---	Hemmer (foot), plain bottom, $\frac{3}{8}$ in. hem
36415	5881	Hemmer (foot), plain bottom, $\frac{1}{4}$ in. hem
36471	5881	Hemmer (foot), plain bottom, $\frac{1}{4}$ in. hem, slotted for lace
36480	---	Hemmer (foot), plain bottom, $\frac{3}{8}$ in. hem
36416	---	Hemmer (foot), plain bottom, $\frac{1}{8}$ in. hem
35926	---	Hemmer
590b	13665	" Adjusting Screw
1443b	13665	" Screw
35927	---	" Shank
35540	13664	Hemmer on Shank (adjustable) complete, with right hand lower guide for lace, Nos. 1443b, 35926, 35927 and two 590b
241037	13676	Feed Dog, for 241143
62527	13665	Presser Foot Hinge Pin
40316	---	" " Plate
40317	---	" " Shank
40318	13664	Presser Foot (hinged) complete, for lace running, Nos. 40316, 40317 and 62527
241143	13676	Throat Plate, 53 needle hole, for needle sizes 12 and 13, for 241037
35236	1971	Hemmer on Shank, for $\frac{1}{8}$ in. hem and above, for bottom of shirt waists
241033	13662	Feed Dog, for 26606
52055	---	Presser Foot
26605	13662	Throat Plate, large needle hole, for 241033
26606	13662	Throat Plate, small needle hole, for 241033

TUCKER (LONG ARM)

No.	Plate	Name
36387	5884	Space Guide
35510	5884	" " Base with 35512, 35514 and two 1426E
402D	5885	Space Guide Base Screw
35511	5885	" " Indicator
35512	5885	" " Pin
35513	5885	" " Stop (left)
35514	5885	" " " " Guide Pin..
1426E	5885	" " " " Screw Stud
1657D	5885	" " " " Thumb Nut
17718	5885	" " " " " "
		Washer
35515	5885	Space Guide Stop (right)
1426E	5885	" " " " Screw Stud
1657D	5885	" " " " Thumb Nut
17718	5885	" " " " " "
		Washer
287D	5885	Space Guide Thumb Screw
36388	—	Space Guide complete, Nos. 287D, 35510, 35511, 35513, 35515, 36387, two each 1657D and 17718
35517	5883	Tuck Guide Arm
1177D	5885	" " " Screw
35518	5883	" " Base
50134E	5885	" " " Screw Stud
36389	5883	" " Bracket
307C	5885	" " " Screw Center ...
1513J	5885	" " " " " Nut
36390	5885	" " " Spring
36391	5884	" " " " Plate ...
9D	5885	" " " " Screw
423C	5885	" " " Stop Screw
1520E	5885	" " " " " Nut ..
36392	5883	" " Frame
36393	5885	" " Spring
1510E	5885	" " " " Nut
35524	5885	" " " " Washer ...
803C	5885	" " " Stop Screw
1520E	5885	" " " " " Nut ..
35511	5885	" " Indicator
35525	5883	" " Plate
1115F	5885	" " Screw

No.	Plate	Name
36394	—	Tuck Guide complete, Nos. 9D, 423C, 803C, 1510E, 35511, 35517, 35518, 35524, 35525, 36389 to 36393, 50134E, two each 307C, 1115F, 1177D, 1513J, 1520E and three wood screws 1½ in., No. 10
36395	—	Tucker (long arm) complete, Nos. 35528, 36388, 36394 and two 402D
241029	13661	Feed Dog, for shirt work, for 52032 and 52033
35528	5886	Presser Foot (wide), for 36395
40322	5886	" " (narrow), for use with 36395
36654	5886	Presser Foot, for tucking shirt bosoms
52032	13661	Throat Plate, large needle hole, for 241029
52033	13661	Throat Plate, small needle hole, for 241029
36670	—	Tucker (long arm) complete, for tango tucking, Nos. 36388, 36394, 36654 and two 402D

KNEE LIFTER

For use with Tuck Folder

2759	5877	Lifting Rod with 2761
2761	13665	" " Cap (washer)
2762	13665	" " Collar with 362C
362C	13665	" " " Set Screw
2760	—	Lifting Rod complete, Nos. 2759 and 2762
2763	5877	Rock Shaft
12242	5877	" " Hanger with two wood screws 1 in., No. 10
6335	5877	Rock Shaft Knee Arm
2766	5877	" " " " Hub with 356C
356C	13665	Rock Shaft Knee Arm Hub Set Screw
6336	—	Rock Shaft Knee Arm complete, Nos. 2766, 2767 and 6335

No.	Plate	Name
2767	5877	Rock Shaft Knee Plate with 356c...
356c	13665	" " " " Set Screw...
2769	5877	" " Lifting Arm with 356c...
356c	13665	" " " " Set Screw...
2770	5877	" " Stop Dog with 356c ...
356c	13665	" " " " Set Screw ...
19168	—	Rock Shaft complete, Nos. 2760, 2763, 2769, 6336, two each 2770 and 12242

WOOD BASE

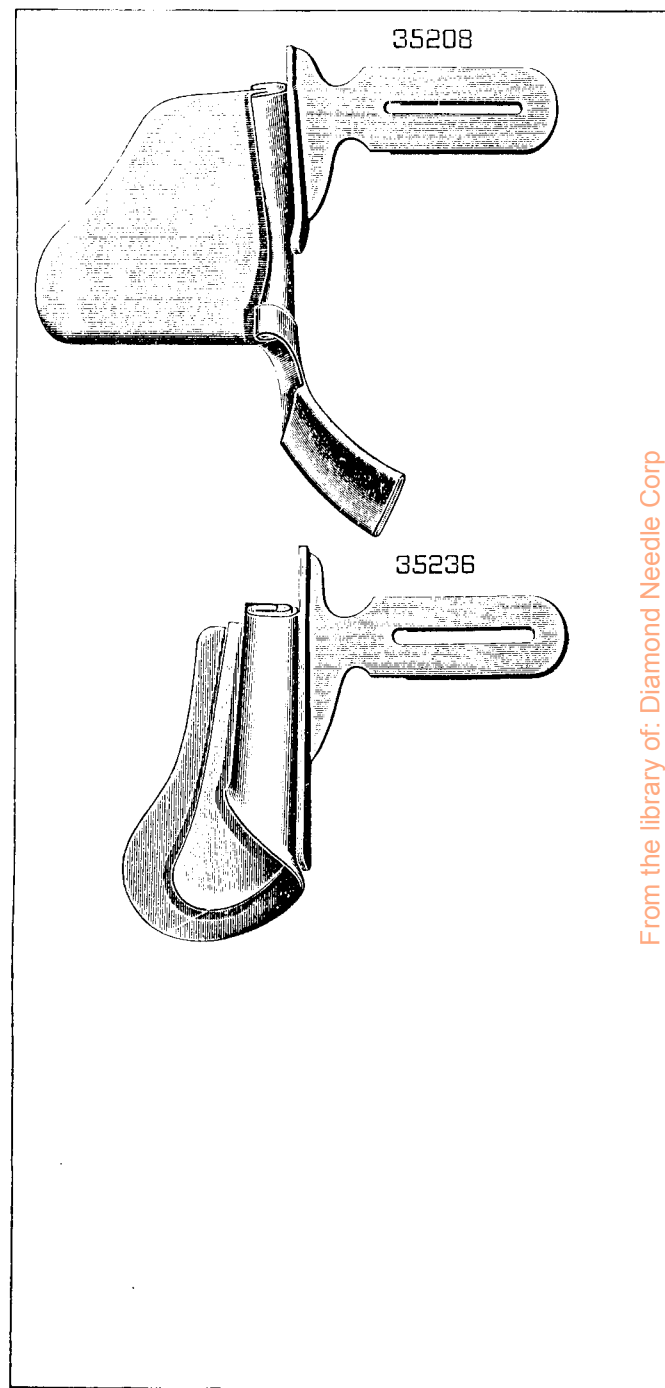
For use with Tuck Folder

79627	—	Bench Stand Section (back) with two each 20022, 27878, 44139, wood screws 1½ in., No. 14 and ¾ in., No. 14
79626	—	Bench Stand Section (front) with wood screw 1½ in., No. 12, two each 20022, 27878 and wood screws ¾ in., No. 14
228231	—	Drip Pan
44139	—	Machine Hinge Plate
20022	—	" Rest (felt)
27878	—	" " Rivet
79628	—	Bench Stand (sectional) complete, Nos. 79626 and 79627

MISCELLANEOUS PARTS

Used in Conjunction with Thread Unwinder

60913	14263	Spool Weight with 60914
60914	—	" " Center Pin
225377	14263	" Wire, for small spools



From the library of: Diamond Needle Corp

PLATE 5089—FULL SIZE

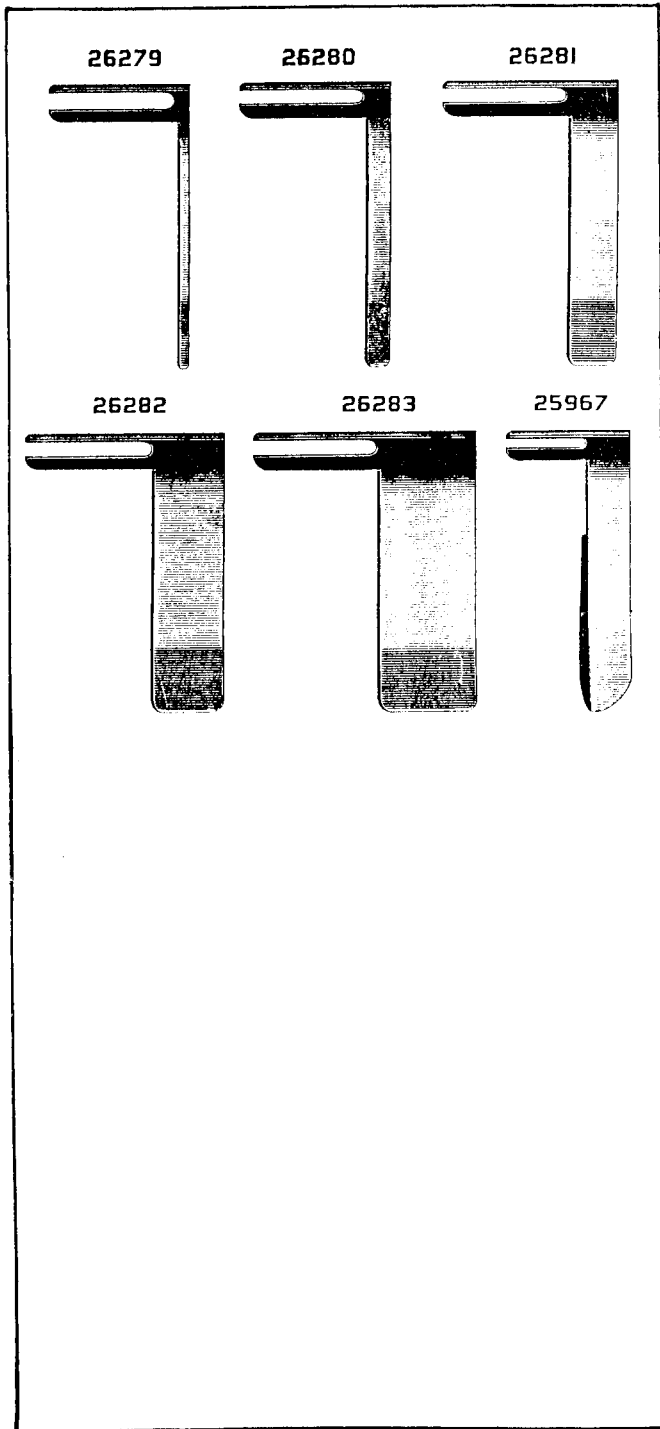


PLATE 5862—FULL SIZE

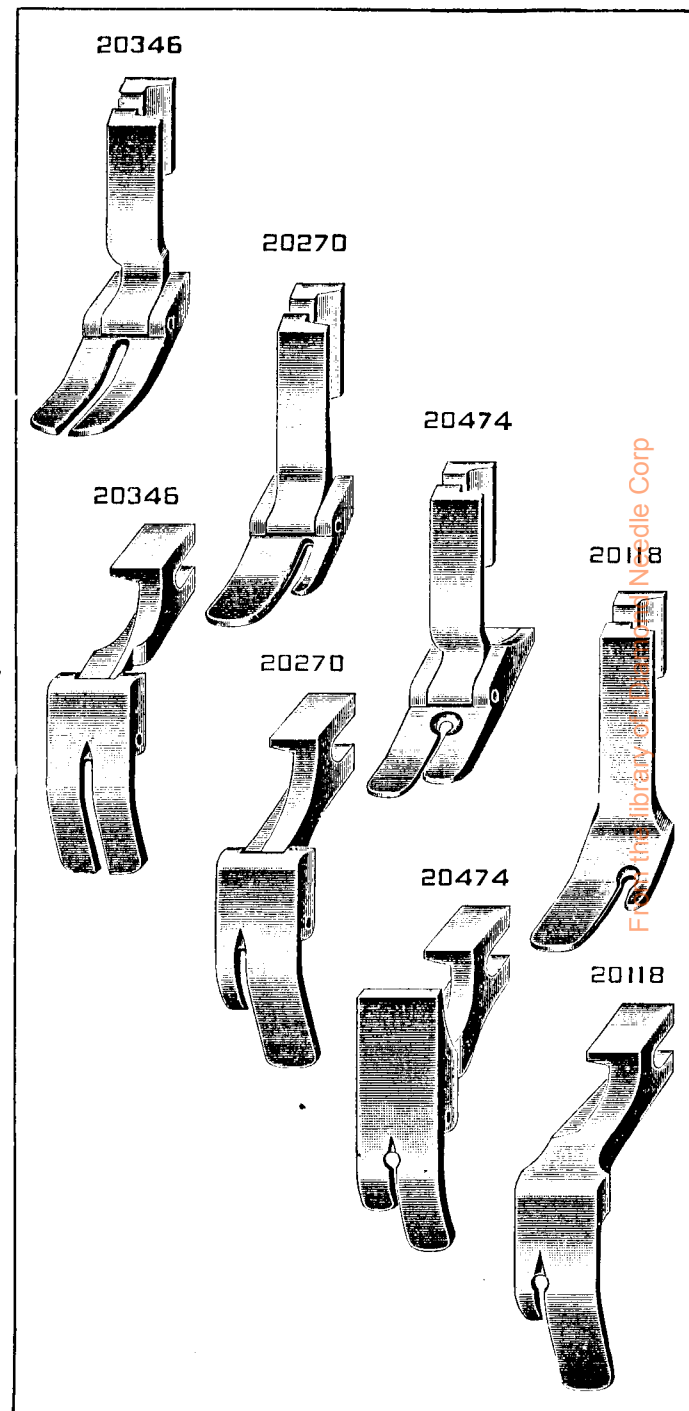
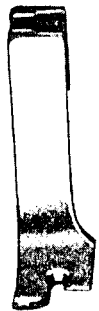


PLATE 5863—FULL SIZE

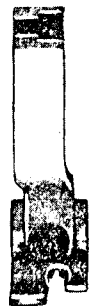
20150



20342



52036



40315



20150



20342



52036

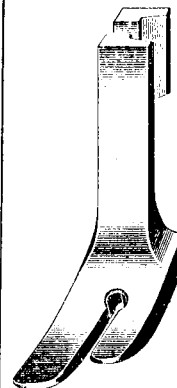


40315

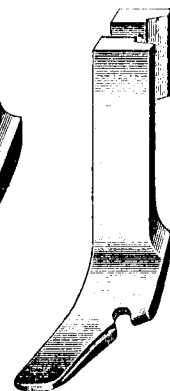


PLATE 5864—FULL SIZE

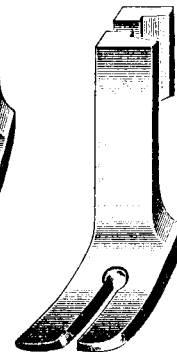
12261



12143



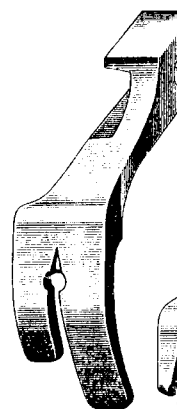
12144



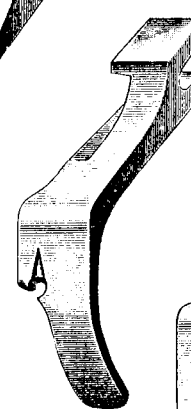
12260



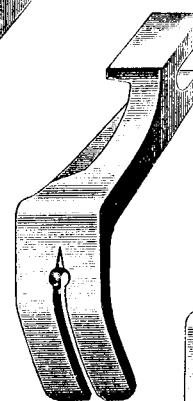
12261



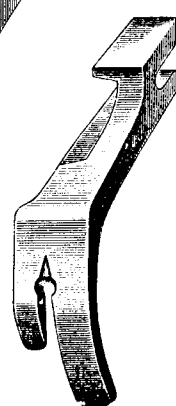
12143



12144



12260



From the library of: [Diamond Needle Corp.](#)

PLATE 5865—FULL SIZE

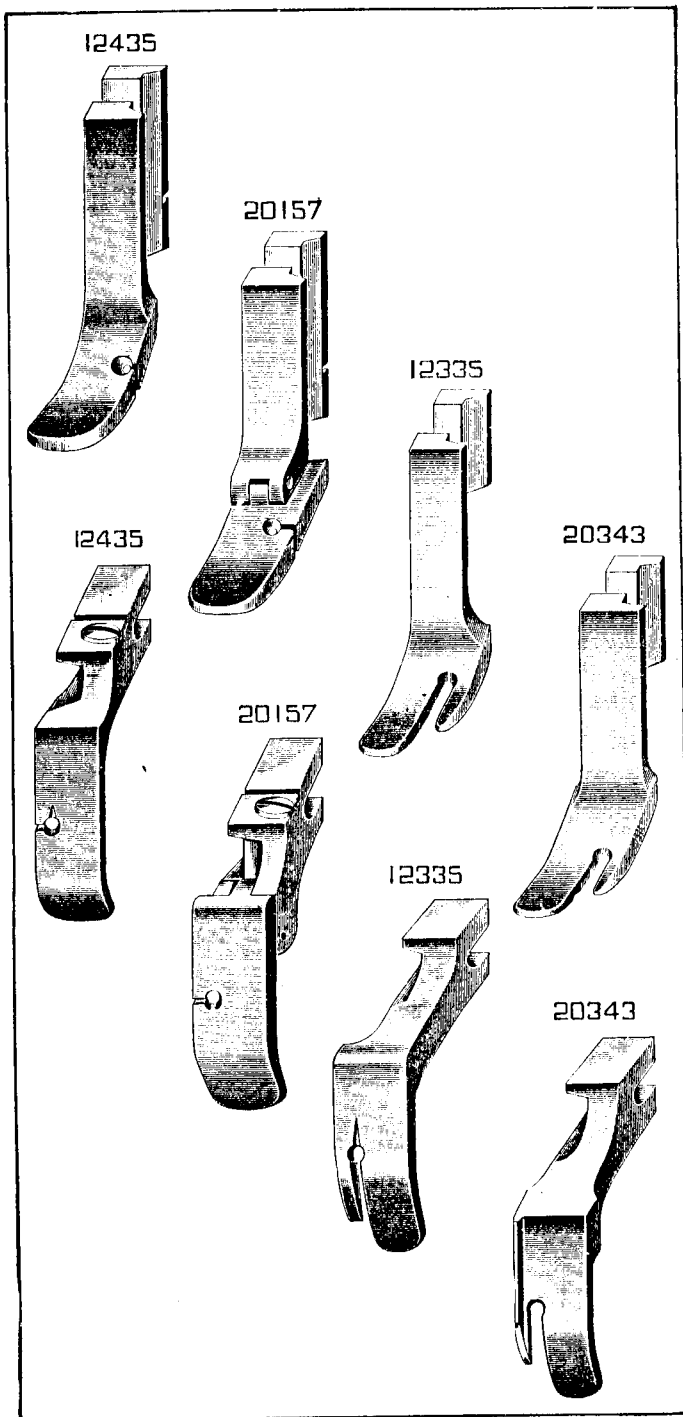
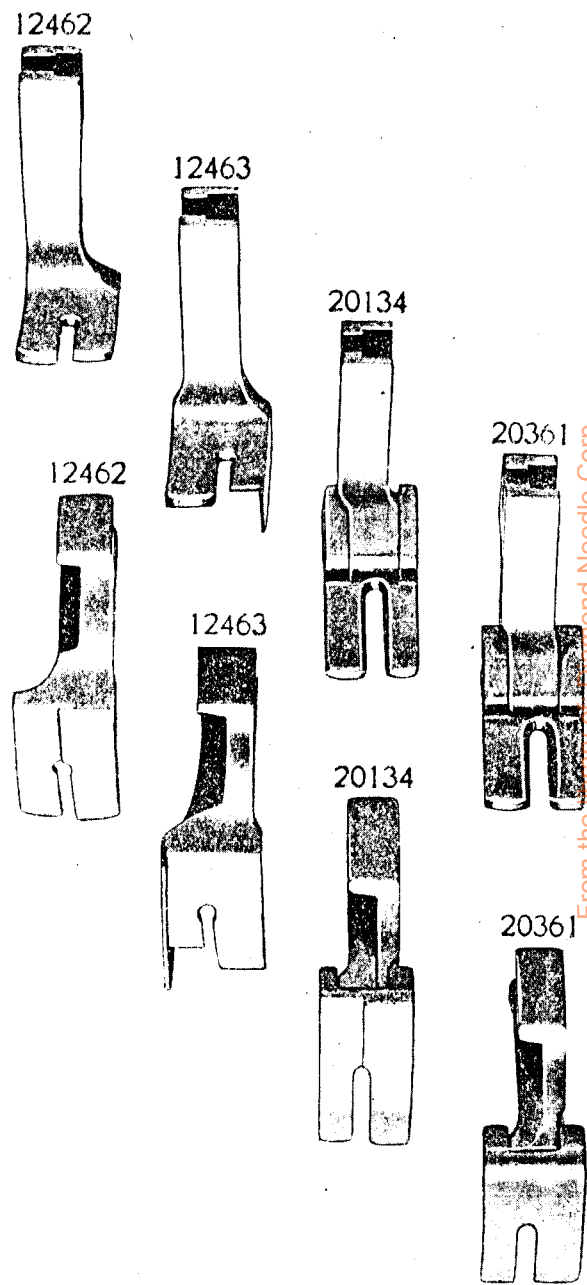


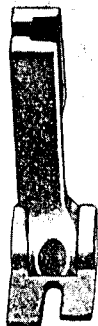
PLATE 5866—FULL SIZE



From the library of Diamond Needle Corp

PLATE 5867—FULL SIZE

24983

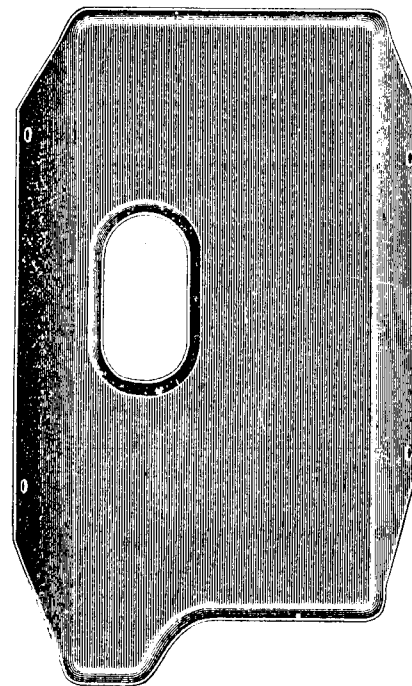


24983



PLATE 5877—ONE-FOURTH SIZE

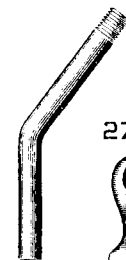
24079



2759



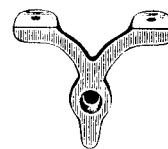
6335



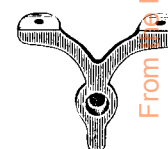
2769



12242



12242



From the library of Disarmament Needle Corp

2777

2778

6337

2763

2766

2765

2770

2767

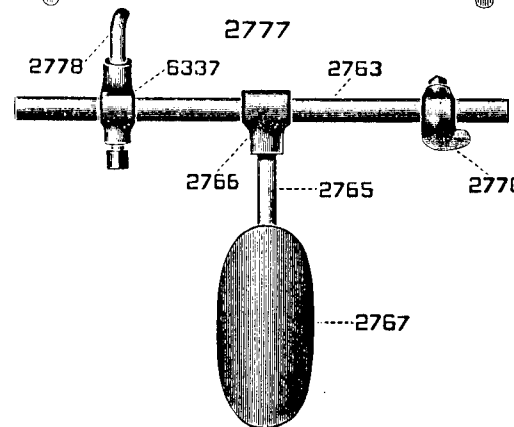


PLATE 5881—FULL SIZE

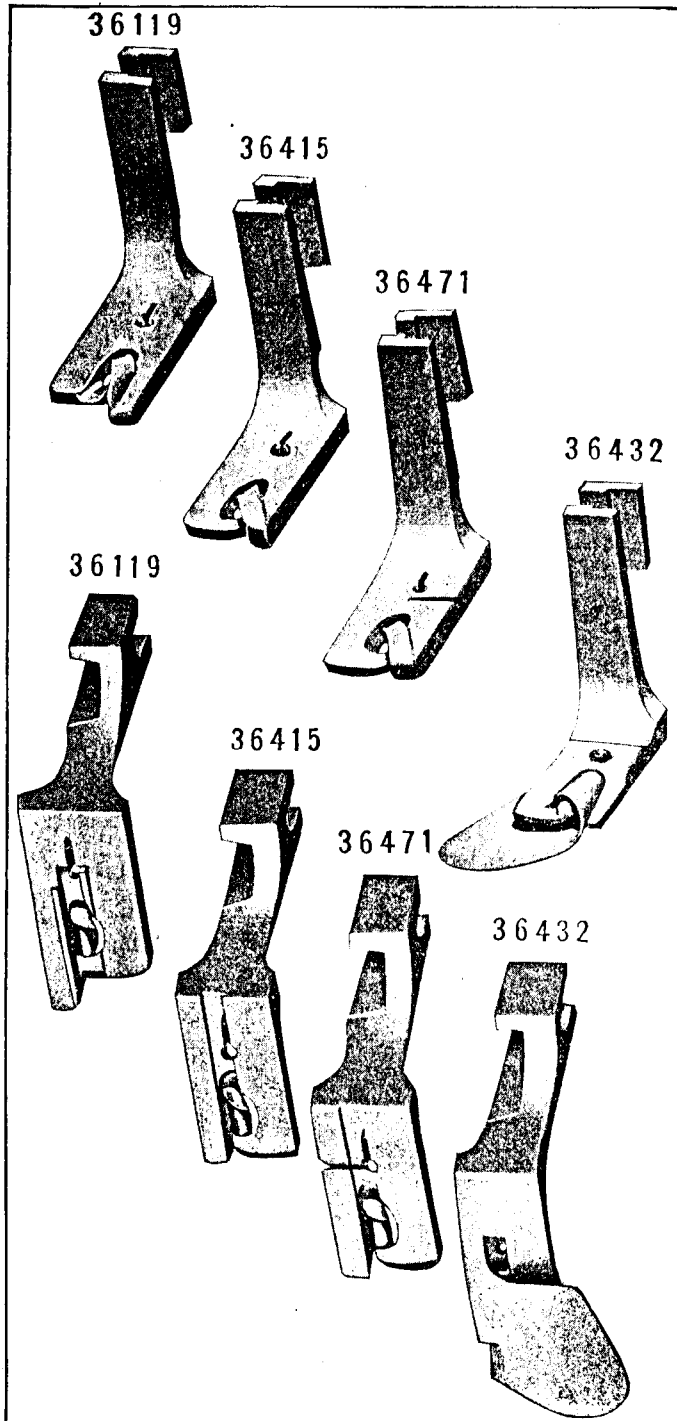


PLATE 5883—ONE-FOURTH SIZE

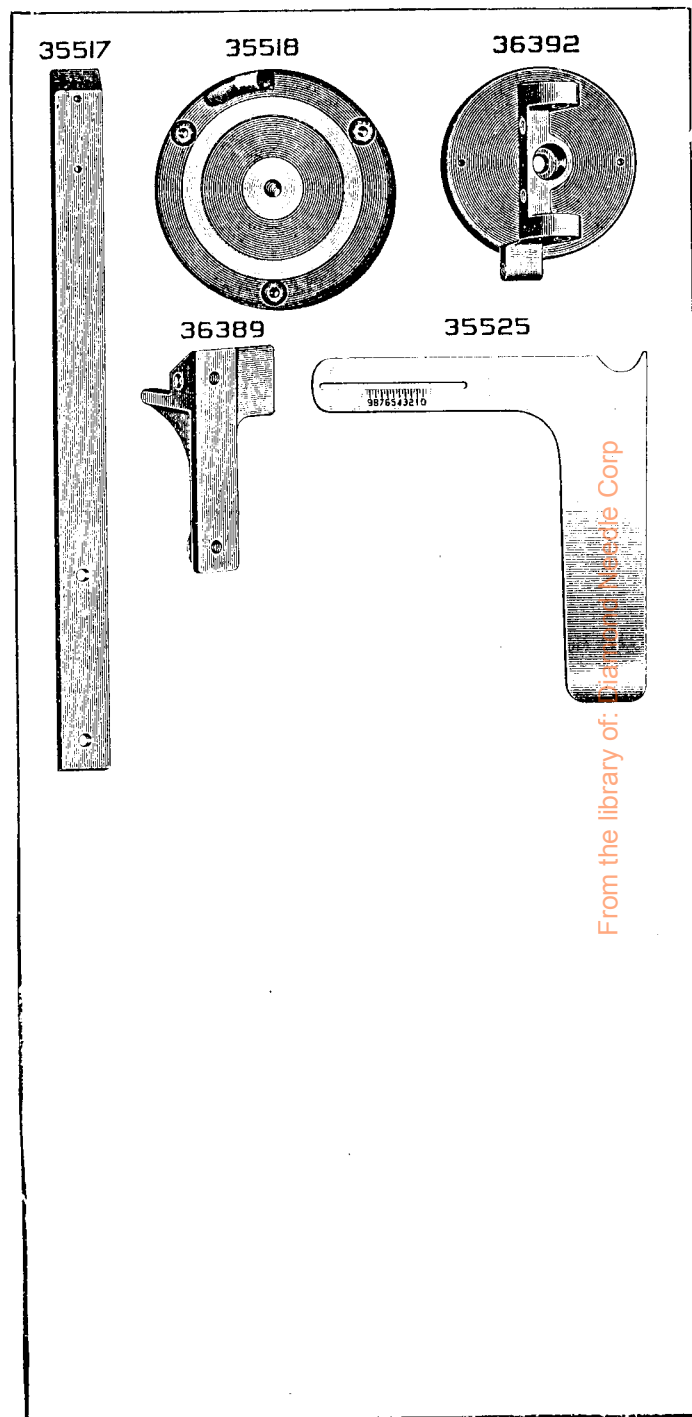
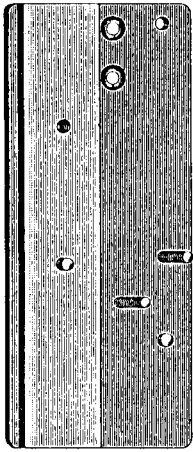


PLATE 5884—ONE-HALF SIZE

36387



35510

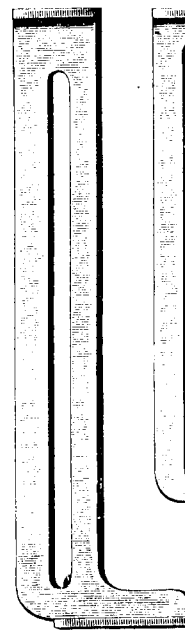


36391

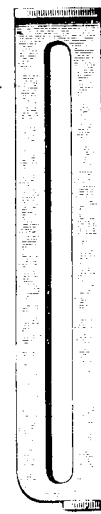


PLATE 5885—FULL SIZE

35513



35515



35511



1426



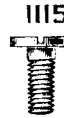
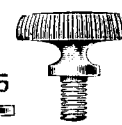
35512



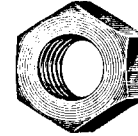
35514



287



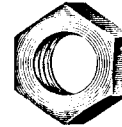
1510



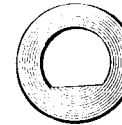
307



1513



35524



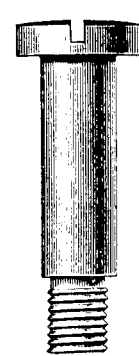
1177



50134



9



36393



1657



17718



402



423



1520



803



36390



From the library of: Diamond Needle Corp

PLATE 5886—FULL SIZE

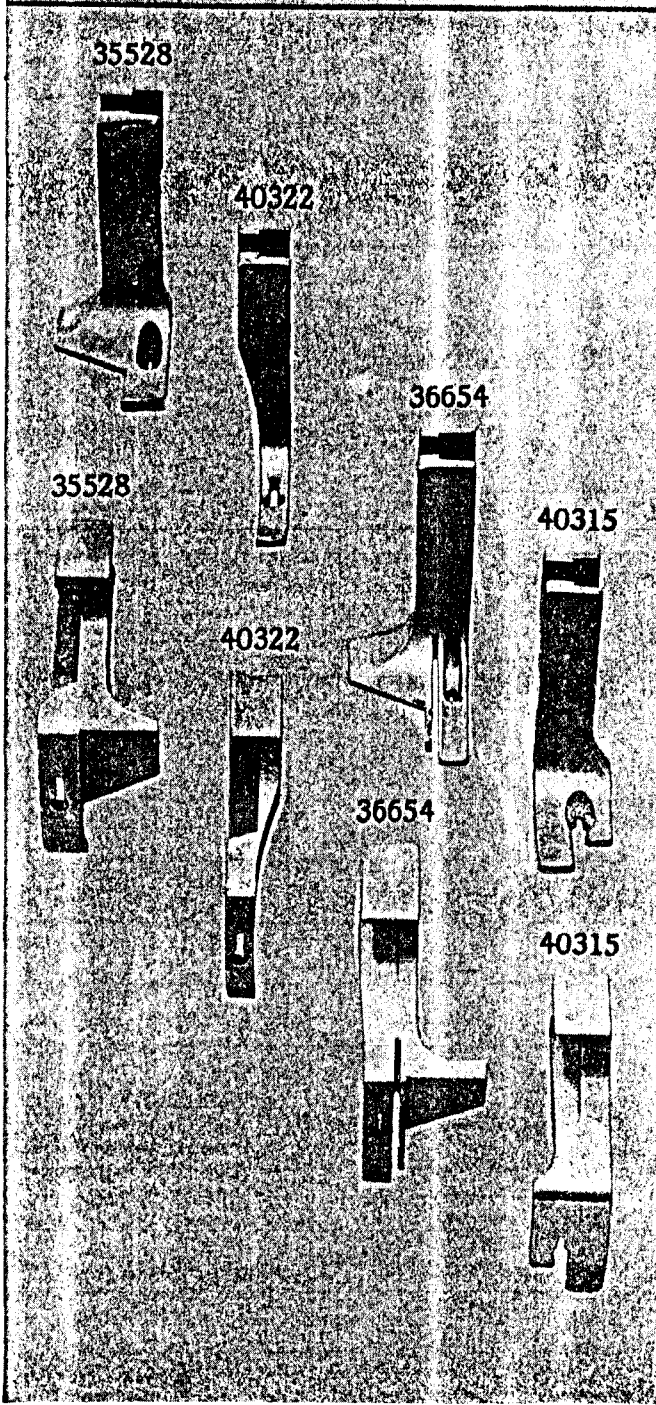
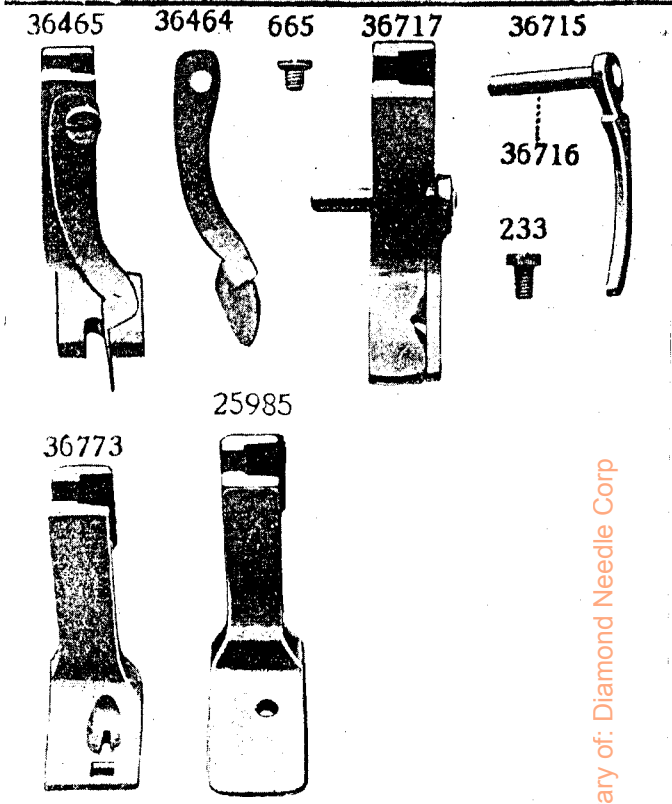


PLATE 5892—FULL SIZE



From the library of: Diamond Needle Corp

PLATE 5945—FULL SIZE

36575



36574



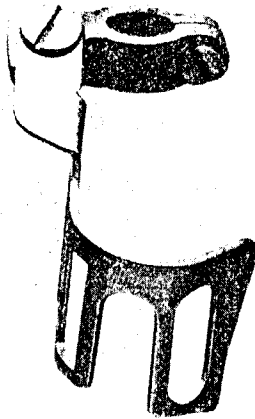
36576



50202



36821



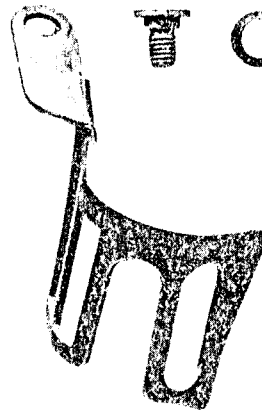
36820



196



36818



50316

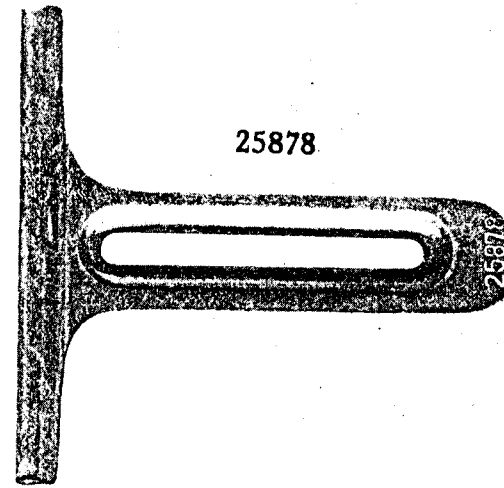


36819

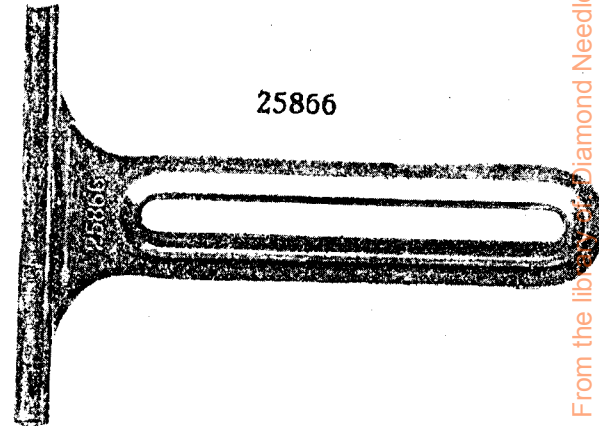


PLATE 6449—FULL SIZE

25878



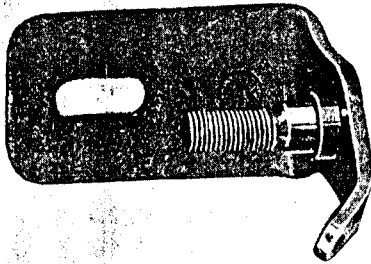
25866



From the library of Diamond Needle Corp

PLATE 10881—FULL SIZE

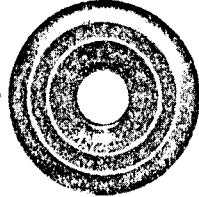
225461



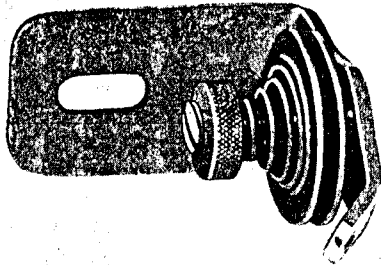
200082 202104



2102



225462



202407



201499

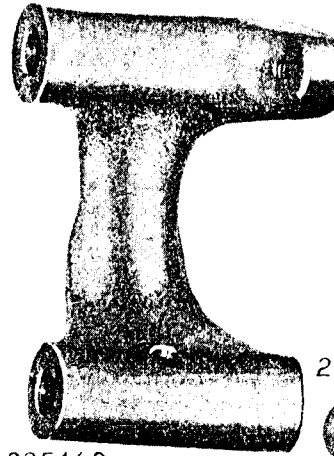


201572

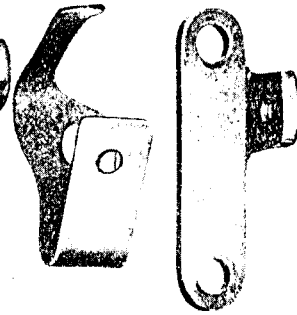


PLATE 10884—FULL SIZE

225453



225444 202478



228026



225458



225460



225454



200299



225438



200056



225459



200105



225456



225381



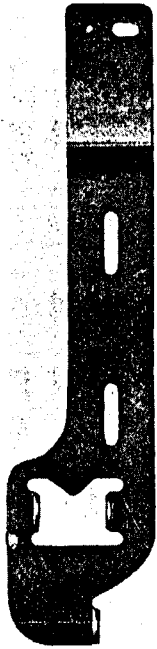
225455



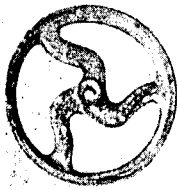
From the library of: diamondrecoils.com

PLATE 10885—ONE-FOURTH SIZE

225433



202473



225382



PLATE 13651—FULL SIZE

204235



1008



443



201400



286



200335



54897



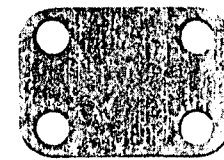
725



200328



241022



241023



123



4307



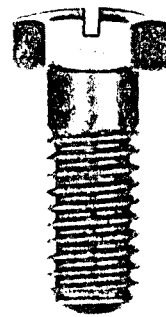
241024



241026



201305



201389



241025



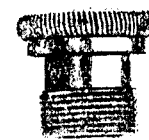
200607



226



200949



202595



200429



241027



200046



241028



200383



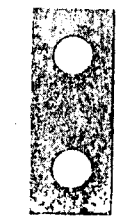
1299



200256



241058



241059



201525



241110



202301



From the library of: Diamond Needle Corp

PLATE 13656—FULL SIZE

241071 210545 178 5601 1521

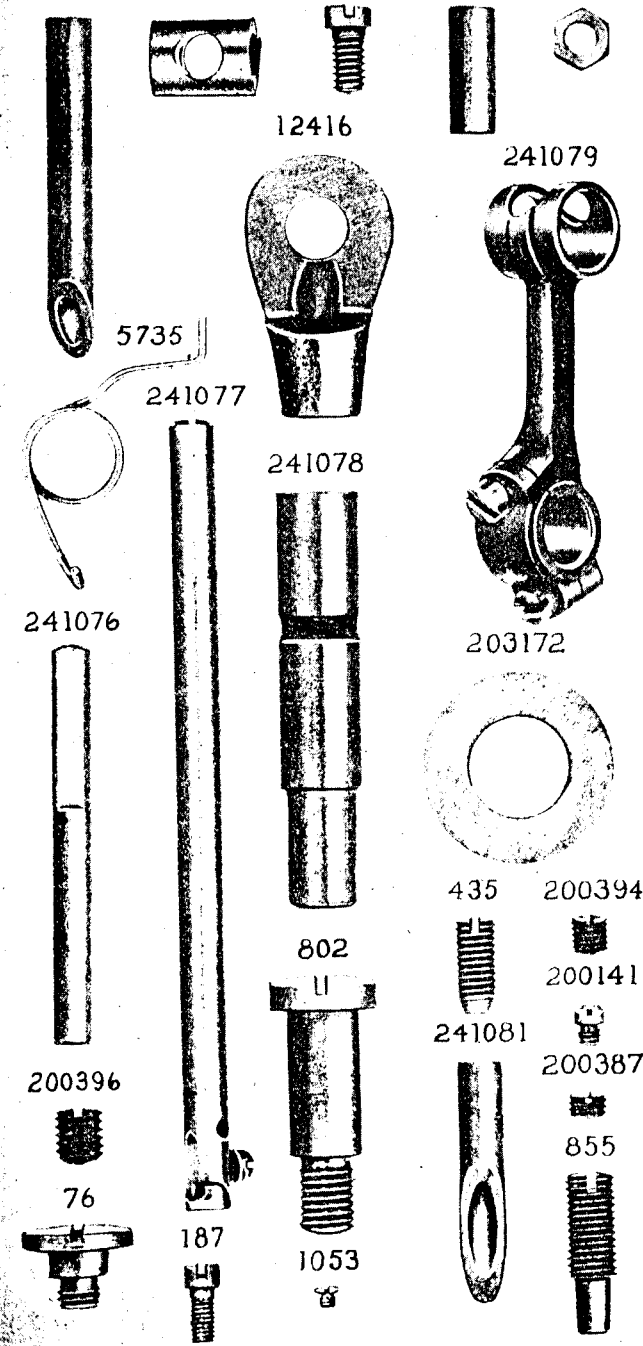
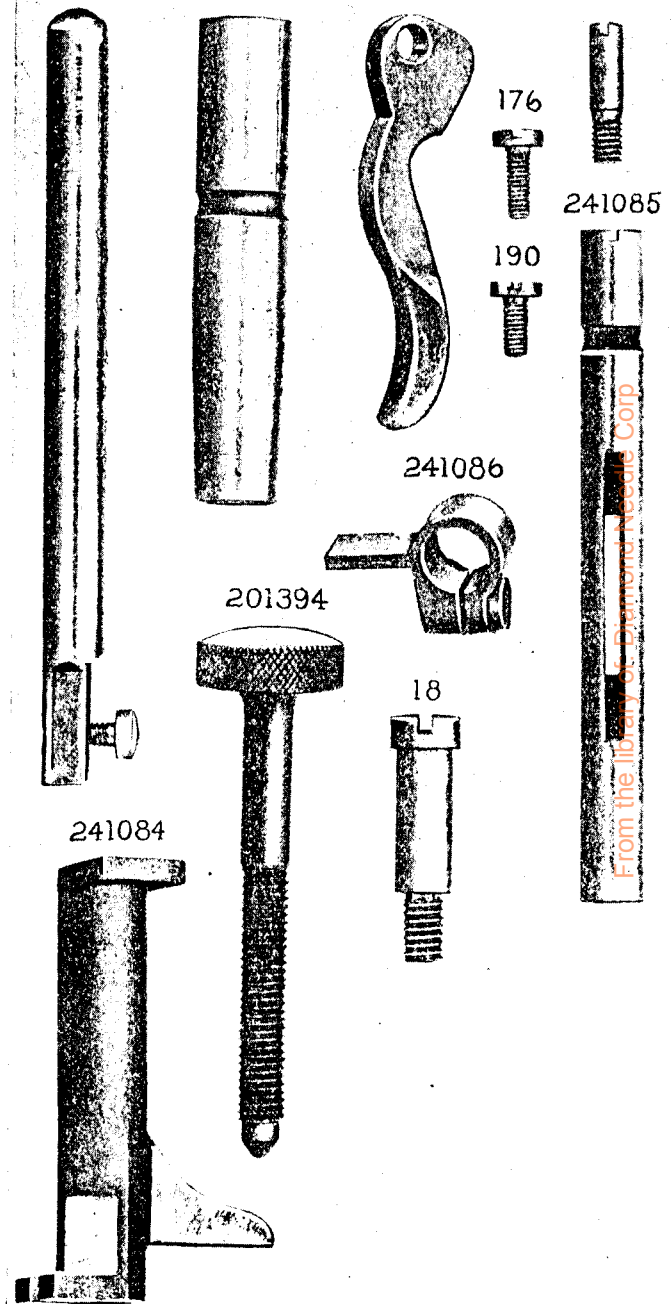


PLATE 13657—FULL SIZE

241082 241083 202339 200666



From the library of the University of Toronto

PLATE 13658—FULL SIZE

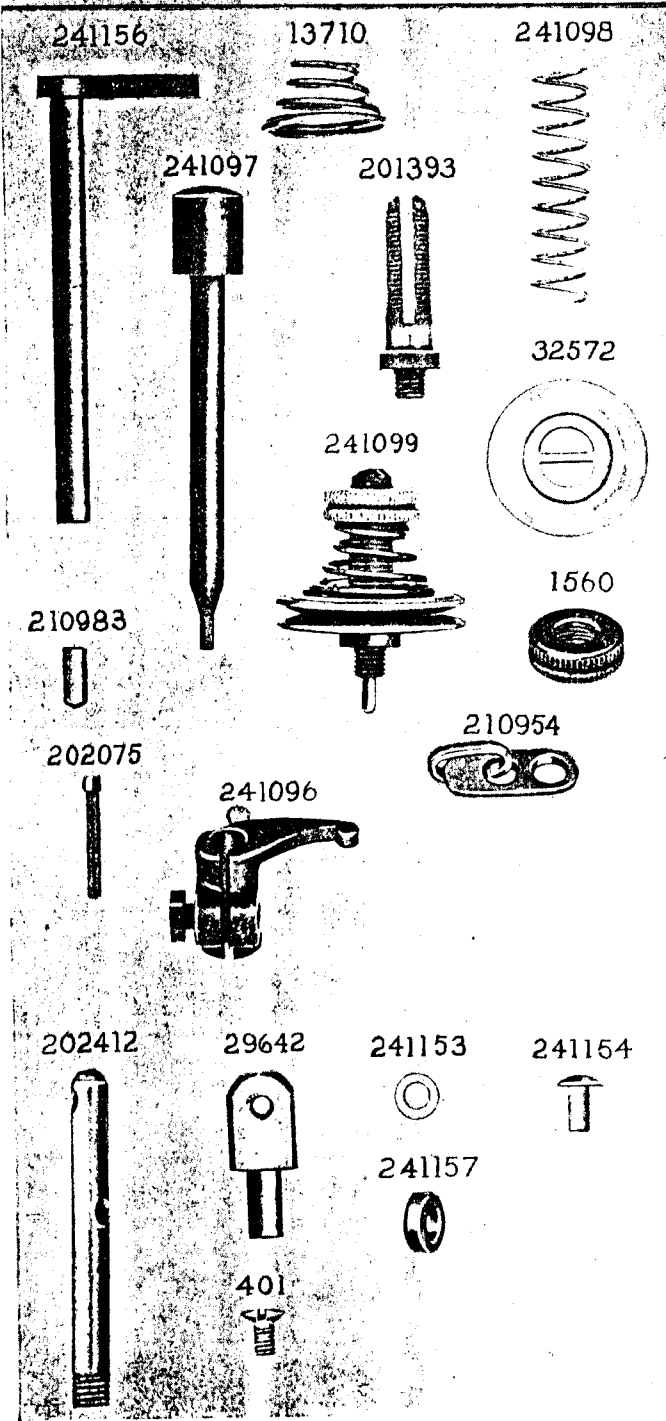


PLATE 13661—FULL SIZE

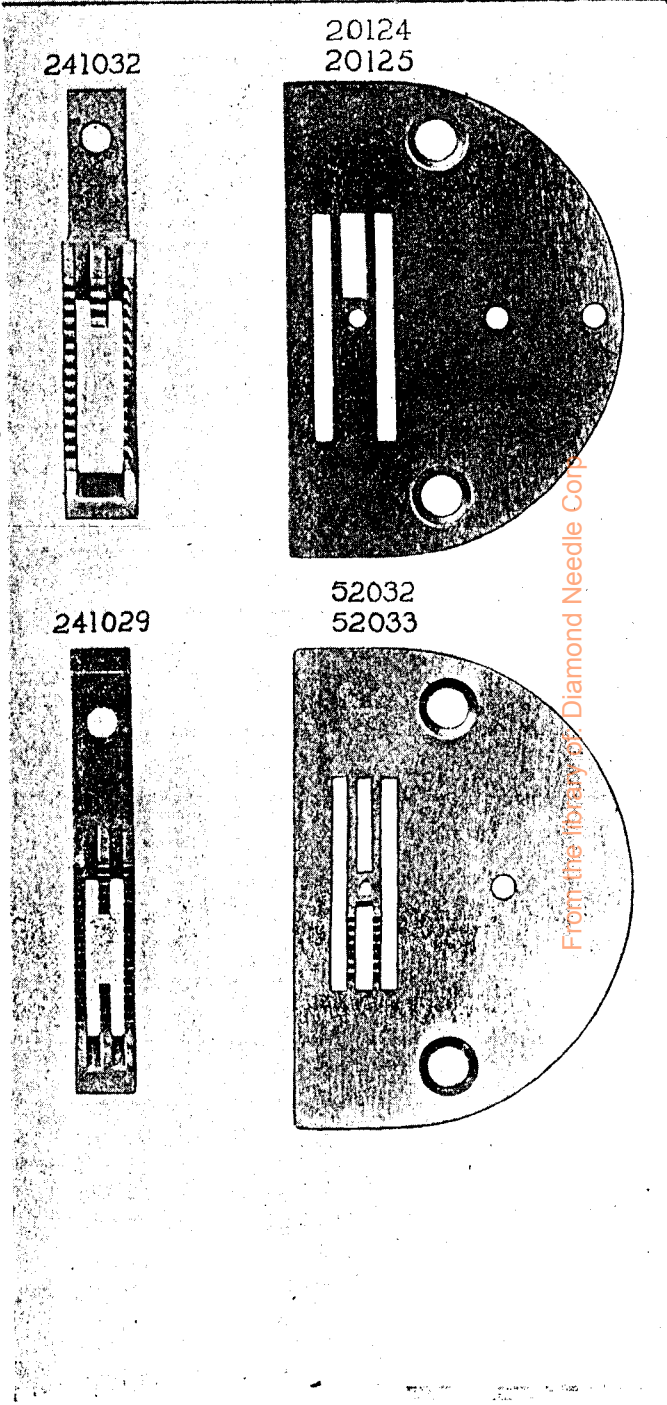
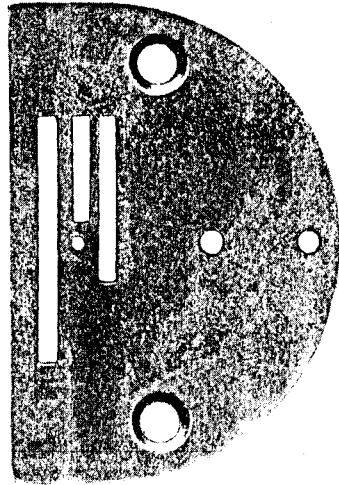


PLATE 13662—FULL SIZE

241031



20139
20140



241033



26605
26606

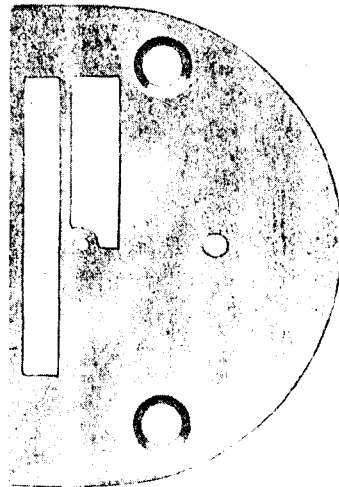


PLATE 13664—FULL SIZE

225421



225423



225424



225425



225426



225428



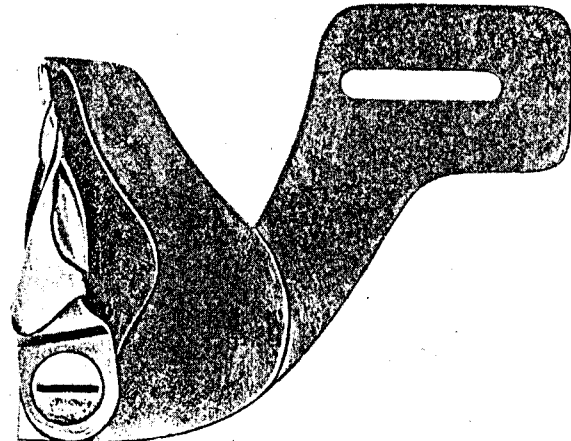
35682



40318



35540



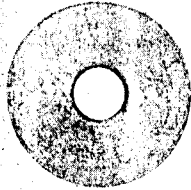
From the files of Diamond Needle Corp

PLATE 13665—FULL SIZE

200363



2761



2762



202486



1443



62527



7298



26276



362



356



228



590

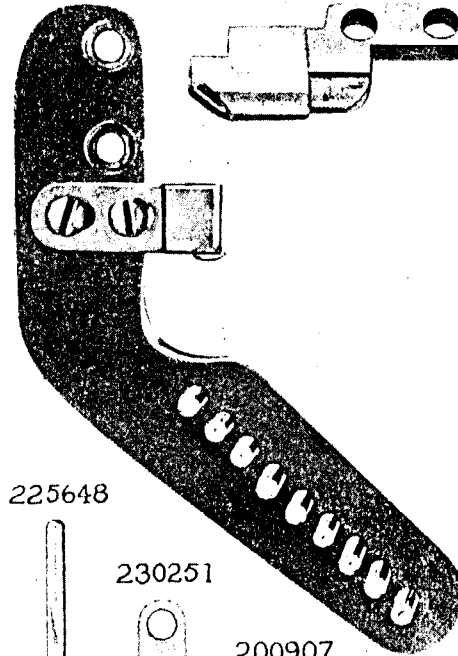


2532

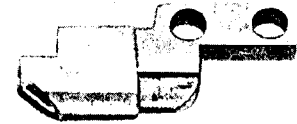


PLATE 13670—FULL SIZE

231081



231078



231087



200463



225648



230251



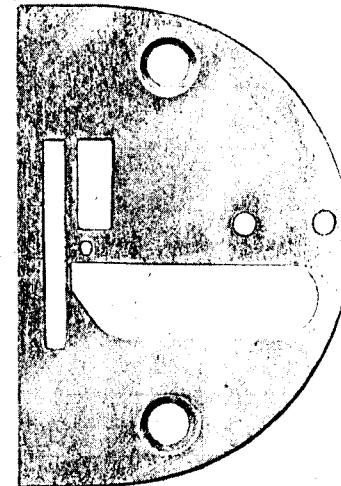
200907



231084



231083



From the library of: [Diametree.com](http://www.diametree.com)

PLATE 13674—ONE-FOURTH SIZE

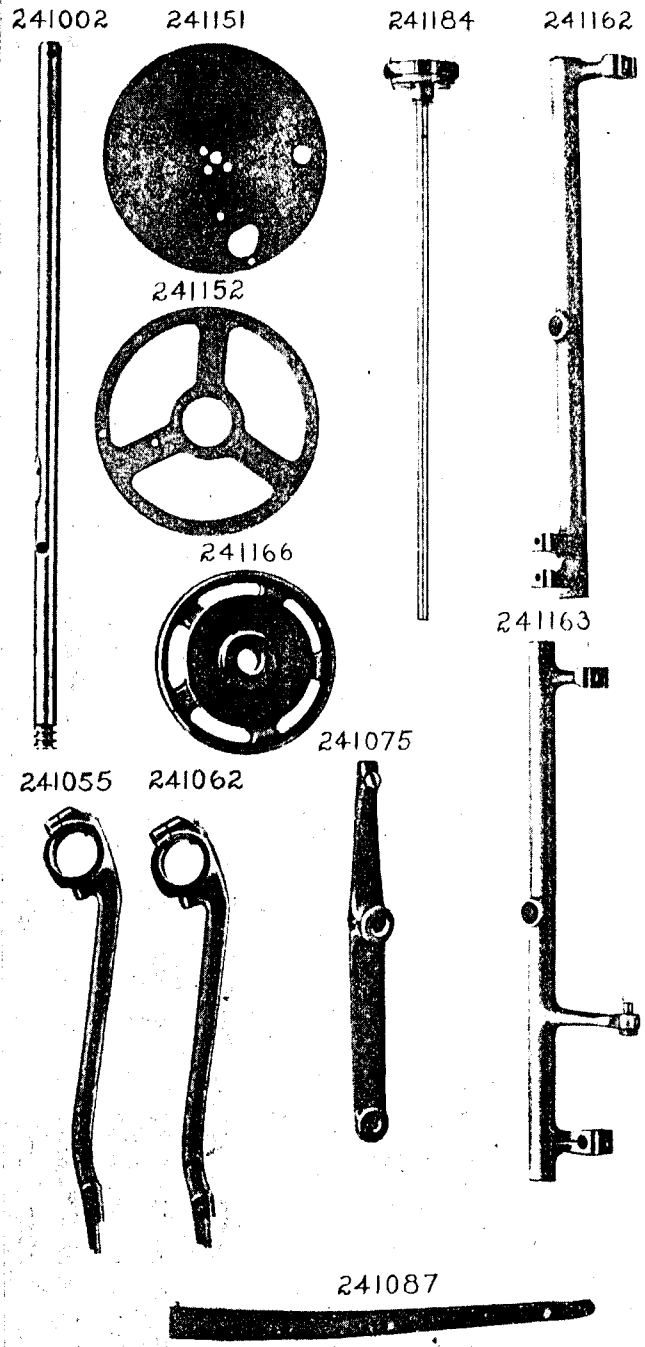
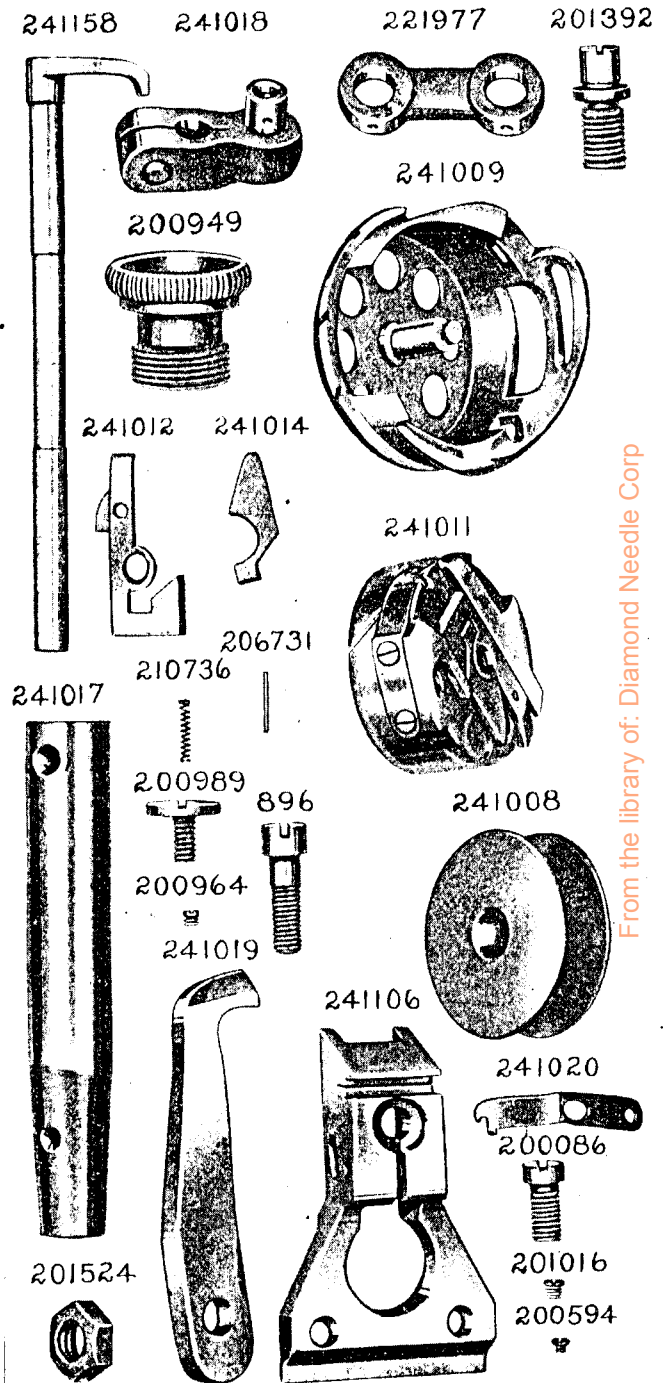


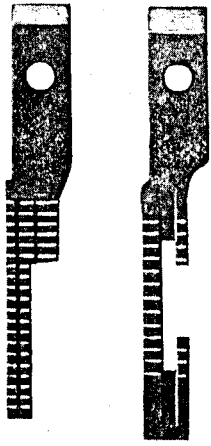
PLATE 13675—FULL SIZE



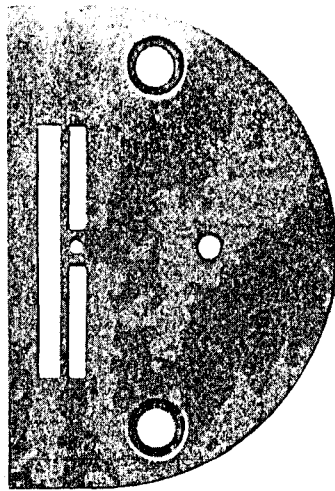
From the library of: Diamond Needle Corp

PLATE 13676—FULL SIZE

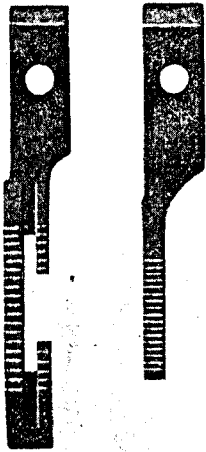
241034 241037



241143



241038 241202



24444

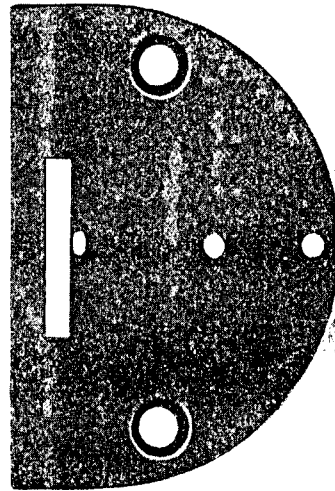


PLATE 13677—FULL SIZE

241201



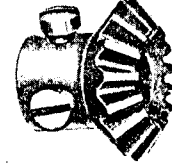
241180



241188



241111



241072

40217



241125



241108



201318



201388

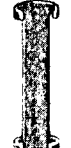


241169

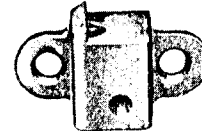


241170

210554



241167



121



202443



241182



241183



241103



241104



50234



448



455



465



1253



241114



691



444



430



1149



202619



241109



460



200583



1036



232382



PLATE 13678—FULL SIZE

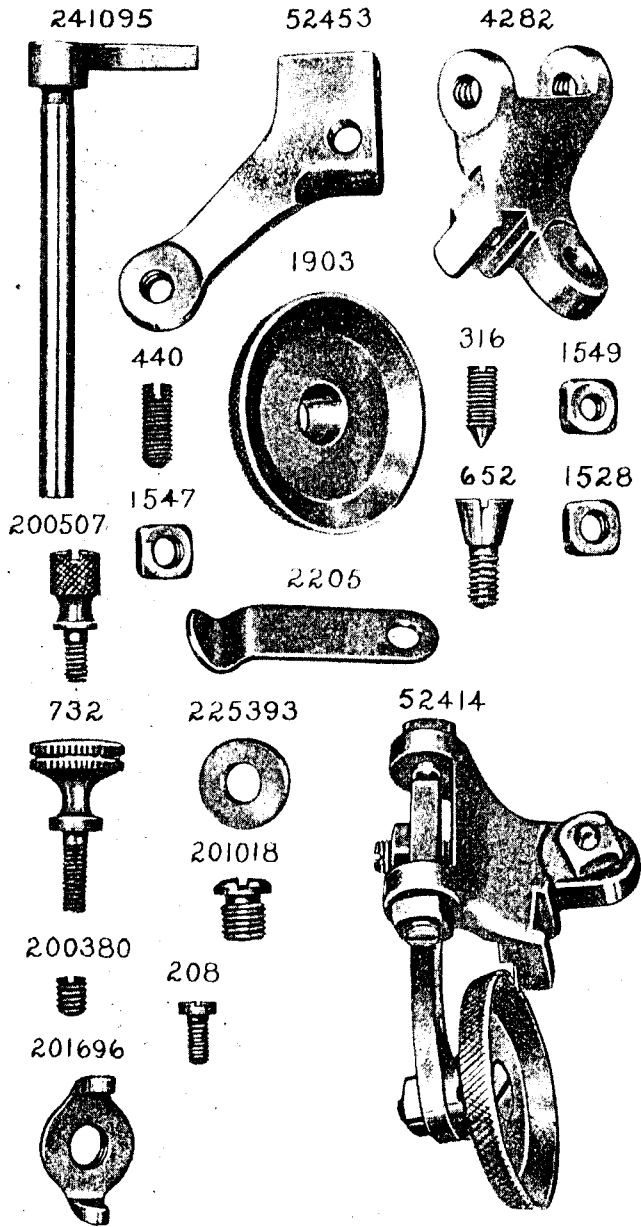


PLATE 13679—ONE-HALF SIZE

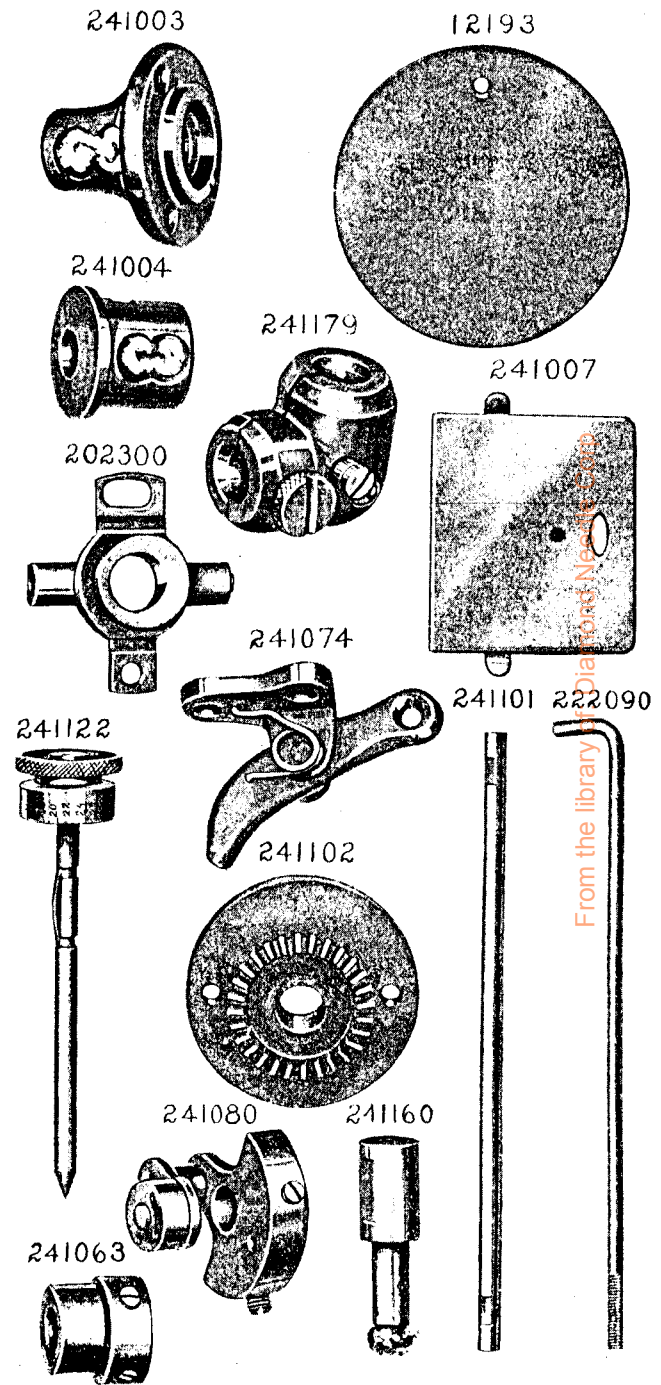


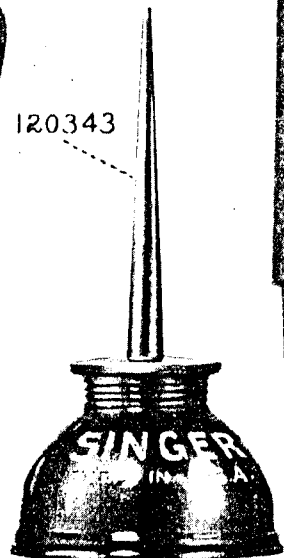
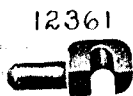
PLATE 13680—ONE-HALF SIZE

26026

26485

120342

41400



225554



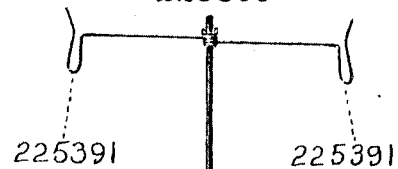
PLATE 14263—ONE-SIXTH SIZE

225377

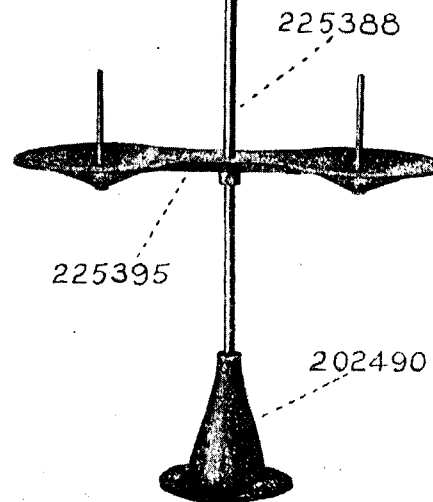
60913



225396



225392



From the library of: Diamond Needle Corp